

Network Resource Management System for Grid network service

Michiaki Hayashi

KDDI R&D Laboratories Inc.

Oct. 5, '05

NRM as a GNS enabler

- AIST/KDDI R&D Labs/NTT/NICT's joint work on defining **GNS (Grid Network Service) interface**
- Network resource management system (NRM)'s primary services
 - Network monitoring and information service (Query/Discovery)
 - Advance reservation and data transport service (Reservation/Queuing)
 - Modification of queue or reservation (Modification)

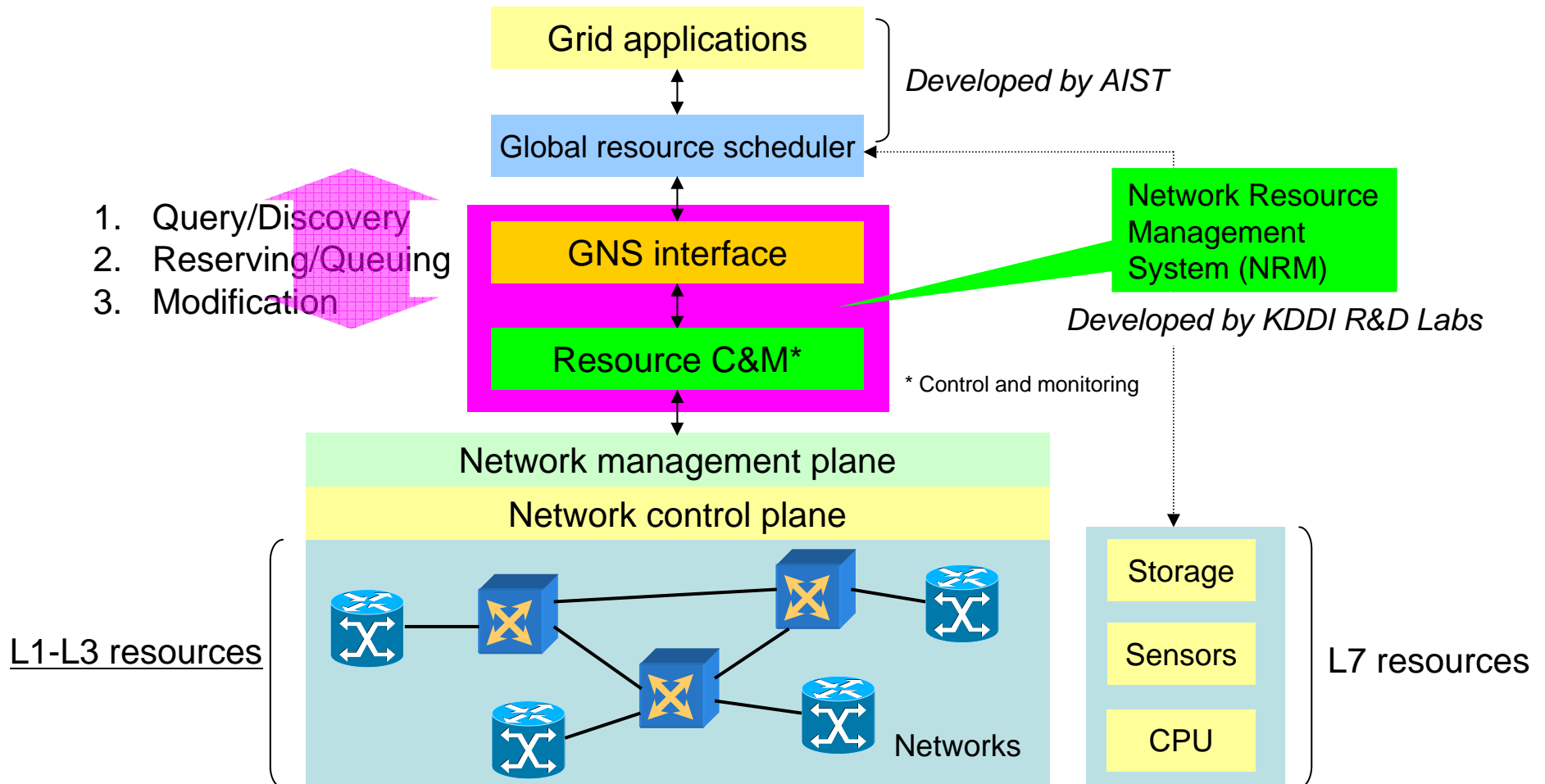

NRM architecture and implementation

- Arrangement of network resource for grid application via GNS-WSI*1
 - Advance reservation according to **WSDL-defined service requirement and procedure**
 - **RPC-based** service request and monitoring over **SOAP/HTTP messaging**
- Mediation functionality between application request and network resource
 - **Topology abstraction and virtualization** of GMPLS optical networks
 - Lambda-path **scheduling** of multiple **advance reservations**
- Control and monitoring (C&M) of GMPLS networks
 - Provisioning of lambda-paths through network control IF
 - Monitoring of **status and performance** of lambda path

*1 GNS Web-Services Interface

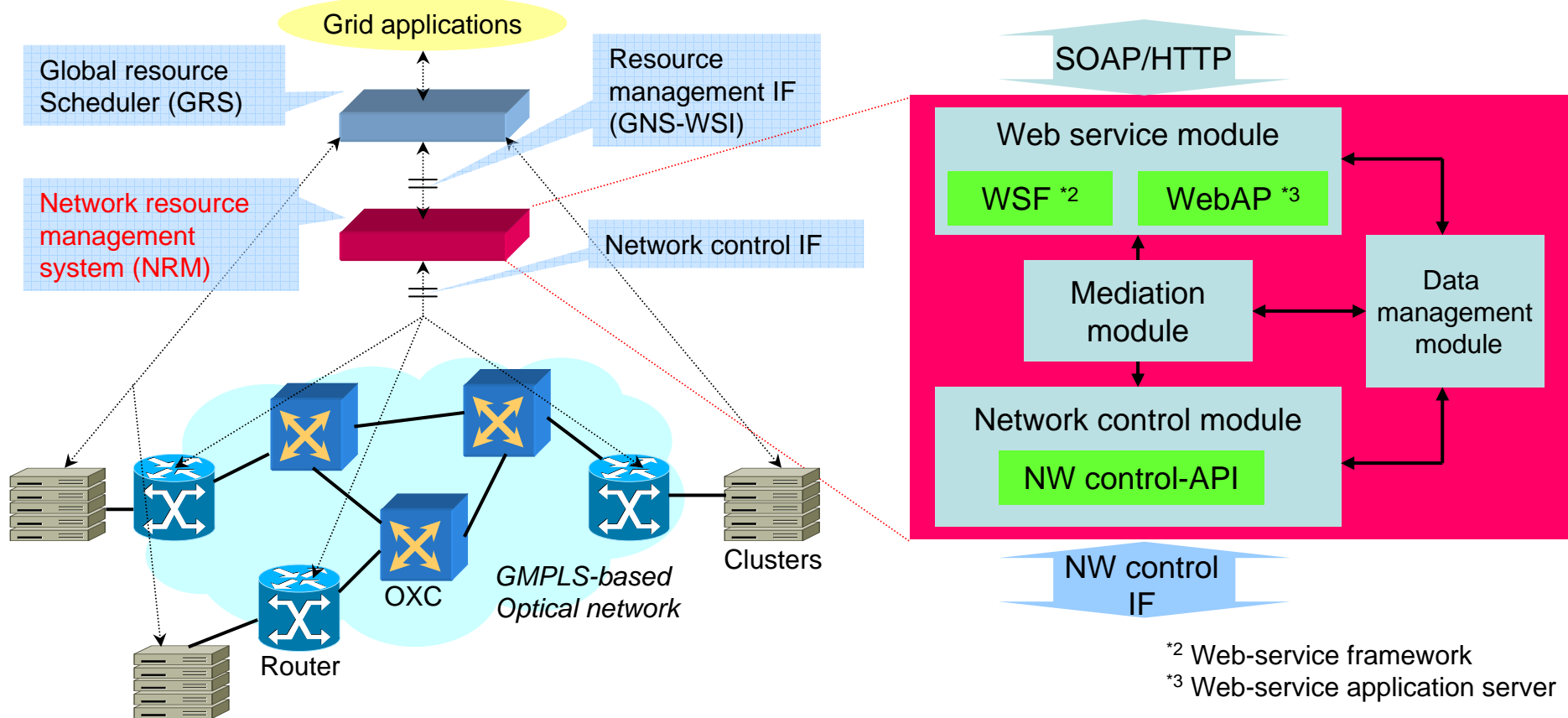

*2 Web-service framework

*3 Web-service application server

Profile of GNS-WSI service parameters

- Six methods are implemented to provide GNS
 - Methods are initiated by GRS (NRM responds to the relevant HTTP port)
 - **Reservation and Forced release** (Network reservation service)
 - **Query** (Network information service, Status check of reservation/queue)
 - **Modification** (Time and BW parameters)
- Status parameters for network information service
 - Availability (Specific resource or network topology)
 - Status of reservation and queue

SOAP methods

#	Method name	Operation
1	netResourceReservation	Network resource reservation requests
2	netResourceModification	Modification of reserved or queued requests
3	netResourceReservationStatusQuery	Query of reservation status or queuing status
4	netResourceRelease	Forced release of reserved or queued requests
5	netResourceQuery	Query of specific network resource availability
6	netAvailableResourceQuery	Query of topology view available to serve

Status parameters

#	Status code name
1	<i>Reserved code #</i>
2	Available
3	Not available
4	Queued
5	Queuing error
6	Queuing modified
7	Queuing modification error
8	Queuing cancelled
9	Reserving
10	Reserved
11	Reservation error
12	Reserve modified
13	Reservation modification error
14	Releasing
15	Released
16	Release error

Advance reservation operation

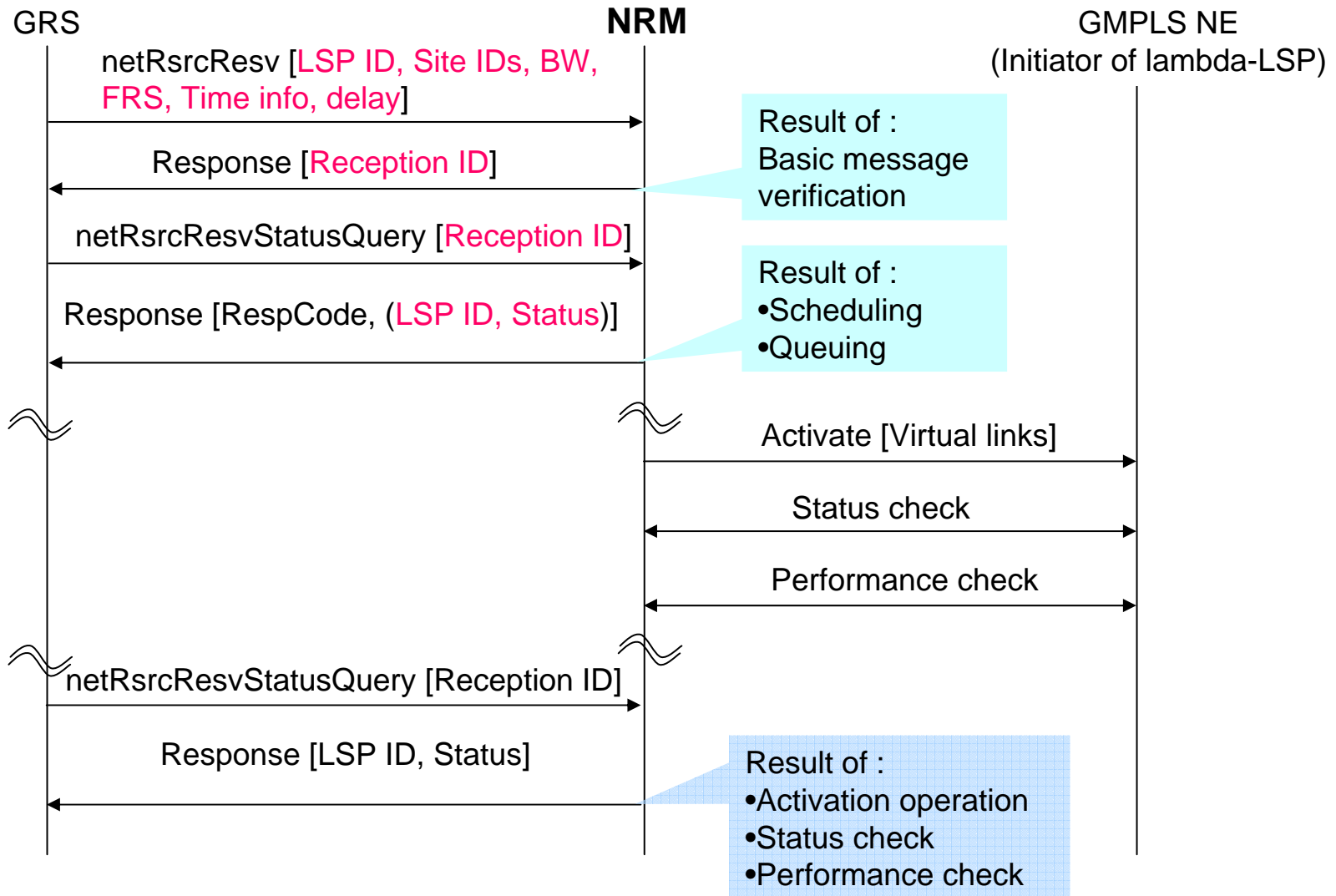

Network resource virtualization and control

- Network resource virtualization
 - GMPLS network consists of number of TE-links, routers and OXCs, etc.
 - Lambda LSPs : **Virtual links** between end points -> Policy-based **network virtualization**
 - Resource **scheduling based on the virtual links**
 - IP addresses : **Site ID**
- NRM adaptively access GMPLS edge nodes
 - **Ingress nodes** of lambda path
 - Control (Activate/deactivate/monitor/measure) lambda paths with CLI

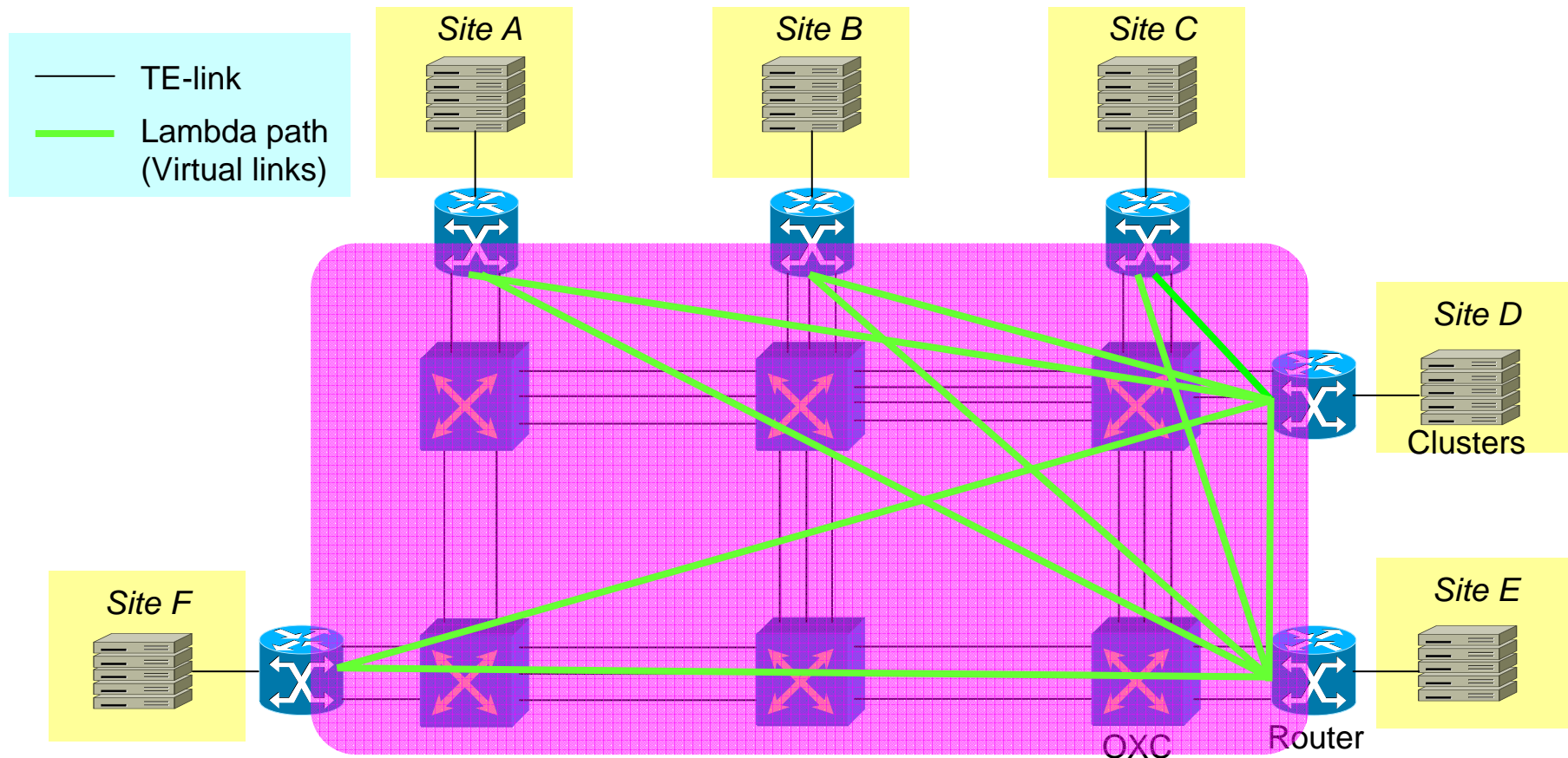

Network service properties (WSDL snapshot for netRsrcResv)

Resource reservation properties (per LSP ID)

```
<sequence>
  <element name="APoint" nillable="true" type="xsd:string"/>
  <element name="ZPoint" nillable="true" type="xsd:string"/>
  <element name="availability" nillable="true" type="xsd:int"/>
  <element name="bandwidth" nillable="true" type="xsd:int"/>
  <element name="delayTime" nillable="true" type="xsd:int"/>
  <element name="endTime" nillable="true" type="xsd:dateTime"/>
  <element name="lspld" type="xsd:int"/>
  <element name="startTime" nillable="true" type="xsd:dateTime"/>
</sequence>
```

Cluster site names

Network parameters

(Delay time, Fault recovery schemes)

Time properties

(Reservation time, Release time)

Resource reservation response properties

```
<complexType name="IResponseLSPInfo">
  <sequence>
    <element name="lspld" type="xsd:int"/>
    <element name="statusCode" type="xsd:int"/>
  </sequence>
</complexType>
<complexType name="IResponseReserveInfo">
  <sequence>
    <element name="receptionId" nillable="true" type="xsd:int"/>
    <element name="responseLspInfos" nillable="true"
      type="impl:ArrayOf_tns2_IResponseLSPInfo"/>
    <element name="returnCode" type="xsd:int"/>
  </sequence>
</complexType>
```

Status code (per LSP ID)

Reception ID

Response code (per reception ID)
(for Ack and Error messaging)

Nation-wide demonstration in iGRID2005

“Coordination of Grid Scheduler and Lambda Path Service Over GMPLS”
-Toward Commercial Lambda Path Service-
(by AIST/KDDI R&D Labs./NTT/NICT)

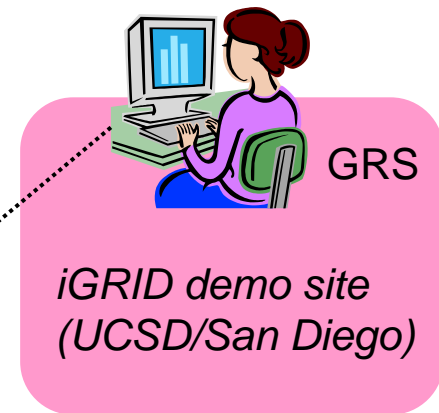
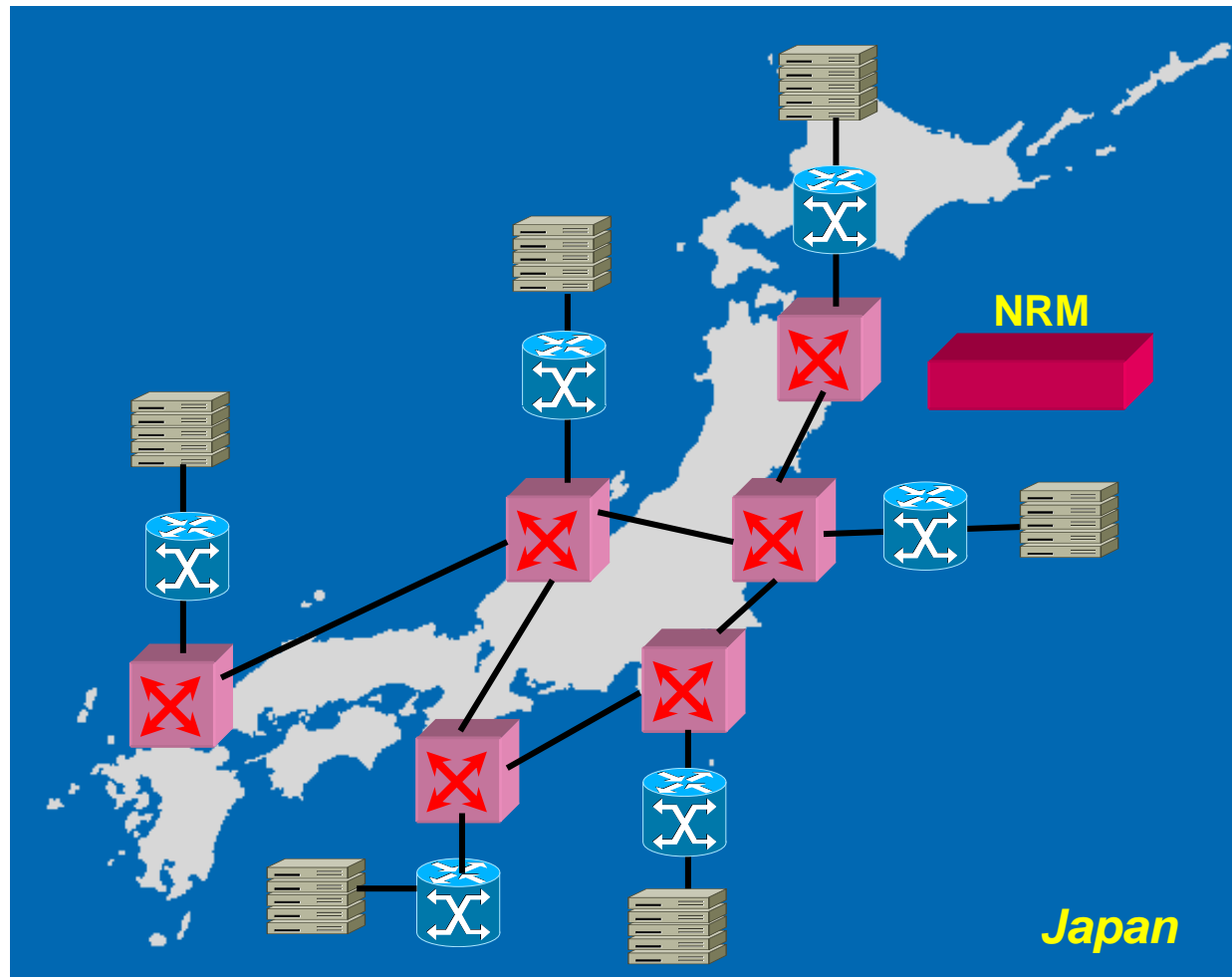

Demonstration overview

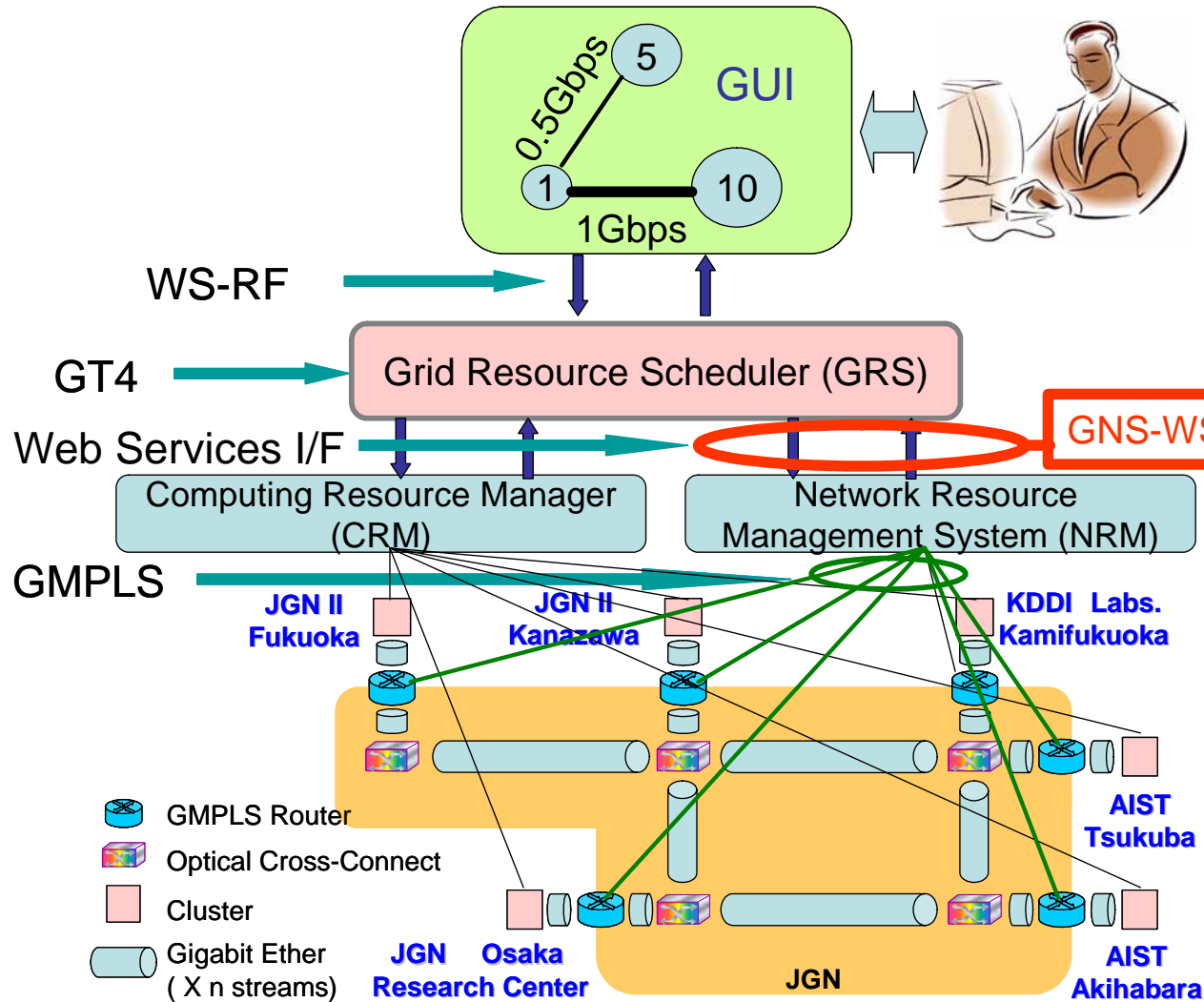

User requests service via GUI, specifying the required number of computers and the network bandwidth needed

The computing resources and GMPLS network resources are reserved as the result of interworking between the GRS and NRM using GNS-WSI (Grid Network Service / Web Services Interface)

A molecular dynamics simulation is executed using the reserved computers and lambda paths. Ninf-G2 and Globus Toolkit 2 (GT2) are used at each cluster.

Summary

- Resource management interface (GNS-WSI) is implemented
 - WSDL definition considering grid application requirements and network properties
- Network resource management system (NRM) for lambda path service
 - GMPLS lambda LSP-based resource virtualization and scheduling
- Successful nation-wide demonstration in iGRID2005
 - AIST/KDDI R&D Labs/NTT/NICT

Next step

- Extension of GNS functionalities
 - More user requirements
 - SLA treatment
 - QoS-awareness
 - etc.
- GNS over multiple policy domains
 - GMPLS interworking at E-NNI interface
 - IP-based interworking